

Designed
TO RESIST



DAS IST Topalit

THIS ISTOPALIT

ROBUST & ATTRAKTIV

Der Name Topalit® steht für außergewöhnliche Produktqualität Made in Austria. Seit 50 Jahren ist die Basis für unseren Erfolg ein bewährtes Produktionsverfahren, bei dem Holzspäne und melaminbehandelte Papierfolien zu einem fugenlosen Hochdruckformteil verpresst werden.

Unsere Kunden profitieren von:

- Konstant hohe Produktqualität
- Einer Designkollektion mit zeitlosen Klassikern und Neuheiten
- Dem einzigartigen Produktvorteil unserer XD Oberfläche®
- Hoher Servicekompetenz

ROBUST & ATTRACTIVE

The name Topalit® represents exceptional-quality products made in Austria. For 50 years, the basis for our success has been a proven production process in which wood chips and paper foils are pressed into a jointless high-pressure moulded part.

Our customers benefit from:

- Consistently high product quality
- A design collection featuring timeless classics and new features
- The unique product advantage of our XD Surface®
- A high degree of service competence



INNOVATIV & SICHER INNOVATIVE & SAFE

Die kratzfeste XD Oberfläche® von Topalit® ist ein einzigartiger Produktvorteil. Sie verleiht den Tischplatten von Topalit® beste Werte bei der Kratzfestigkeit. Die verbesserten Eigenschaften wurden von unabhängigen Forschungsinstituten überprüft und bestätigt.

The scratch resistant XD surface® from Topalit® is a strong product advantage. It provides even better scratch resistance to the surfaces of Topalit® tabletops. The increased wear resistance was tested and confirmed by independent research institutes.

Ausgenommen Logo- und Designplatten.
Except for Logo and Design tabletops.

TABER ABRASER TEST TABER ABRASER TEST

Die Abriebfestigkeit einer Topalit® Tischplatte mit XD Oberfläche® ist um ein Vielfaches höher als bei einer konventionellen Tischplatte. Der Taber Abraser Test zeigt klare Ergebnisse.

The abrasion resistance of the Topalit® tabletops with XD surface® is much higher than the resistance of tabletops with conventional surface. The Taber Abraser test shows a clear result.



XD Oberfläche® von Topalit®
XD Surface® from Topalit®



Konventionelle Oberfläche
Conventional Surface

Logo & Design PLATTEN

LOGO & DESIGN TABLETOPS

KOMMUNIKATIV & UNVERWECHSELBAR

Logoplatten sind perfekte Markenbotschafter. Die Individualdesigns basieren auf Ihren Gestaltungswünschen (z. B. Foto, Logo etc.). Diese Platten spiegeln Persönlichkeit wider und ziehen Blicke an.

Mehr dazu finden Sie auf www.topalit.at



COMMUNICATIVE & DISTINCTIVE

Tabletops with logos are perfect brand ambassadors. The individual designs will be based on your design wishes (e.g. a picture, logo, etc.). These tabletops reflect personality and attract attention.

For more information, see www.topalit.at



CLASSIC *Line*



Seitenansicht
CLASSICLINE
in Originalgröße

CLASSICLINE
side view in
original size

ZEITLOS & HOCHWERTIG TIMELESS & HIGH QUALITY

Zeitloses Design und mit jedem Einrichtungsstil kombinierbar.

Timeless design that can be combined with every furnishing style.

- Ideal für Cafés und Bistros
Ideal for cafés and bistros
- Outdoortauglich
Suitable for outdoor use
- Optisch verstärkter Rand passt hervorragend zu Holz- und Natursteindekoren
Visually reinforced edge fits perfectly for wood and natural stone décors
- Erprobte Robustheit
Tried-and-tested robust design
- Große Format- und Dekorauswahl
Large selection of formats and décors

SMART *Line*



Seitenansicht
SMARTLINE®
in Originalgröße

SMARTLINE®
side view in
original size

MODERN & BELASTBAR MODERN & DURABLE

Einfach smart, modern und praktisch –
ideal auch für den Outorbereich.

*Simply smart, modern and practical – also
ideal for outdoor use.*

- Hochverdichteter Kern
High-density core
- Modern-schlanke Seitenansicht
Modern and slim side appearance
- Outdoor-tauglich
Suitable for outdoor use
- Erprobte Robustheit
Tried-and-tested robust design
- Große Dekorauswahl
Large choice of décors
- Modernes Design muss nicht teuer
sein
*Modern design does not have to be
expensive*
- Rahmenuntergestell vgl. Factsheet
Base frame, see factsheet

COMPACT *Line*



Seitenansicht
COMPACTLINE
in Originalgröße
(Standardkante)

Kante gefast
Plattendicke:
12 mm

COMPACTLINE
side view in
original size
(standard edge)

Bevelled edge
Tabletop
thickness: 12 mm

Weitere Kantenformen auf Anfrage
Other edge shapes on request

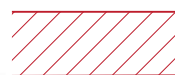

Aufpreis laut Preisliste
Surcharge according to
price list

Kante gerundet
Plattendicke: 12 mm
Rounded edge
Tabletop thickness: 12 mm

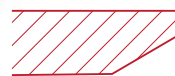

Aufpreis laut Preisliste
Surcharge according to
price list

Kante schräg gefräst
Plattendicke: 12 mm
Angled edge
Tabletop thickness: 12 mm

ELEGANT & VIELSEITIG ELEGANT & VERSATILE

Ein Allrounder, der sich durch moderne Eleganz und Anwendungsvielfalt auszeichnet.

An all-rounder characterised by modern elegance and a wide range of applications.

- Perfekt indoor- und outdoortauglich
Perfect for indoor and outdoor use
- Pflegeleicht
Easy to clean
- Hitzebeständig und verzugsfrei
Heat-resistant and warp-resistant

DESIGN

Holz

WOOD DESIGNS



Atacama Cherry 0222



Alpinemaple 0250



Artisan 0248



Benett 0235*



Bob's Pine 0236*



Fala 0443

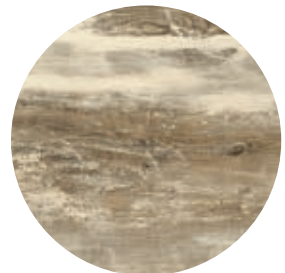

Iceland 0253

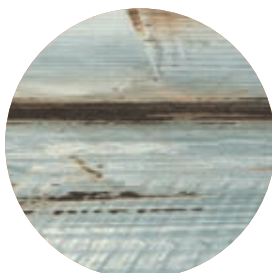

Maritimo Pine 0216

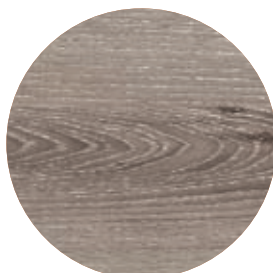

Messina Oak 0227



Oak 0219



Oak Light 0241



Teak 0009*



TiliaTree 0220

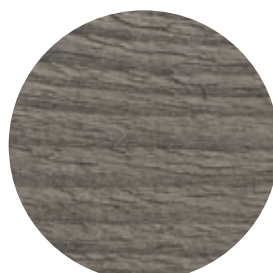

Timber 0214*



Timber White 0232



Urban Spruce 0217



Vintage 0218



Washed Elm 0228



Washington Pine 0226



Wenge 0106*



White Wood 0224



RUN OUT

Zebrano 0242



ONLINE

Dekore in großem Format
ansetzen auf topalit.at!

View the *décors* in larger
format at topalit.at!

* Bestimmte dunkle Dekore und Logotops sind für den Einsatz in direktem Sonnenlicht nur bedingt geeignet. Hier ist verstärkt auf die Verwendung von hochwertigen Tischuntergestellen zu achten.
* Certain dark *décors* and logo tabletops can only be used in direct sunlight to a limited extent. Particular attention must be paid here to using high-quality table bases.

DESIGN

Stein

STONE DESIGNS



Industrial 0240

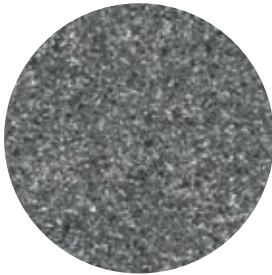

Balota 0119*

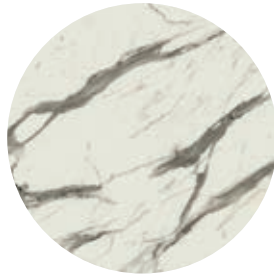

Bianco 0445



Black Marmor 0444*

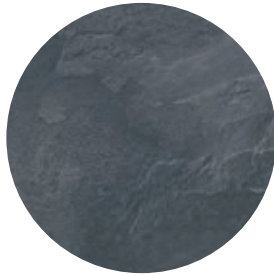

Dark Slate 0231*

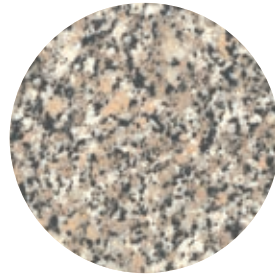

Granit 0067

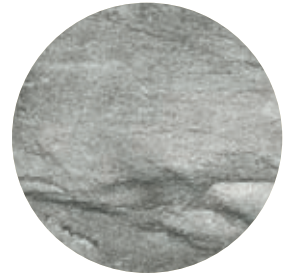

Grizzly 0121



Lavant 0254*



Marble 0246



Nevada 0116



Travertin 0034

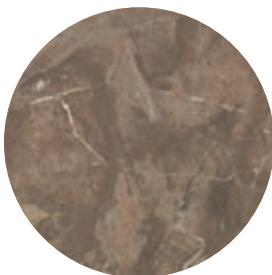

Utah Brown 0223

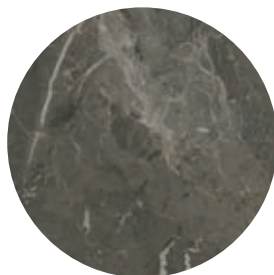

Veneto 0249



White Marmor 0070

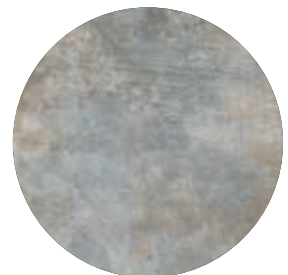

Zinc 0146

DESIGN

Ani

MONOCHROME
DESIGNS



Red 0403

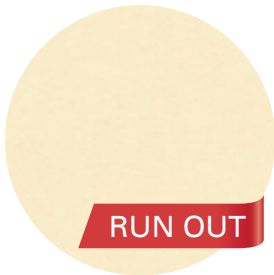

RUN OUT

Beige 0230

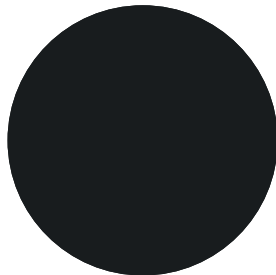

Black 0407*



Cremeweiß 0056

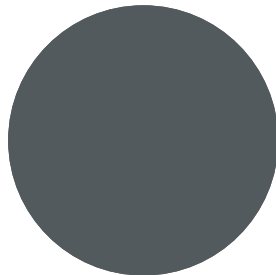

Dark Grey 0252*

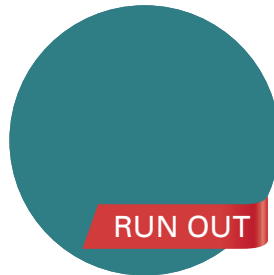

RUN OUT

Petrol 0411

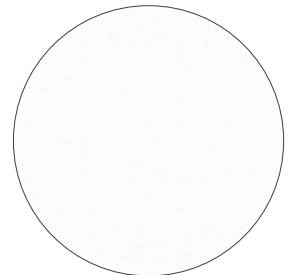

Pure White 0406



ONLINE

Dekore in großem Format
ansetzen auf topalit.at!

*View the décors in larger
format at topalit.at!*

DESIGN

Grafik

GRAPHIC DESIGNS



Newspaper 0151

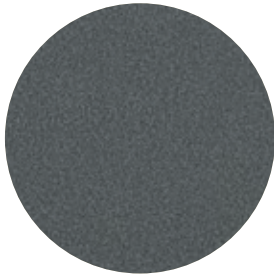

Anthracite 0074*



Aurum 0446*

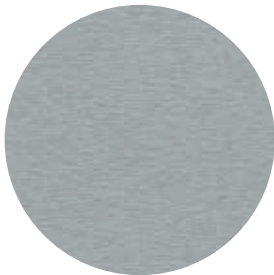

Brushed Silver 0107



Coffee Sack 0233

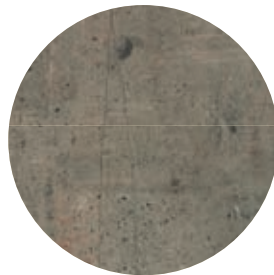

Concrete 0152*



Cyprus Metal 0229*



Etain 0002



Maracaibo 0251



Planchas Blue 0237



Planchas Brown 0238



Planchas Red 0239



Rusty Plates 0234

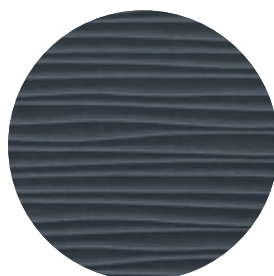

Seagrass Dark 0139*



Seagrass Grey 0138



Seagrass Light 0137



Versailles 0131



ONLINE

Dekore in großem Format
ansetzen auf topalit.at!

*View the décors in larger
format at topalit.at!*

ZUBEHÖR UND

Service

ACCESSORIES AND SERVICE

PRODUKTLINIEN

PRODUCT RANGES

Drei Linien, die Ihren Wünschen entsprechen.
Unsere CLASSICLINE, SMARTLINE® und COMPACTLINE
sind die perfekte Antwort auf Ihre Anforderungen.

*Three ranges which meet your requirements.
Our CLASSICLINE, SMARTLINE® and COMPACTLINE
ranges are the perfect answer to your needs.*



SCHIRMLOCHEINSATZ

PARASOL HOLE INSERT

Wir bieten Ihnen das Bohren des Schirmloches und das
Einsetzen des Kunststoffeinsatzes als Serviceleistung an.
Sprechen Sie uns an, wir machen Ihnen gerne ein indivi-
duelles Angebot.

*We offer you the drilling of the parasol hole and the inser-
tion of the plastic insert as a service.
Please contact us and we will be happy to send you an
individual offer.*



ZIERRINGE & MEHR

DECORATIVE RINGS & MORE

- Zierringe für runde Tische mit einem Durchmesser
von 60 oder 70 cm
*Decorative rings for round tables with a diameter of
60 or 70 cm*
- Polierpaste für Zierringe zum Erhalt der optischen
Qualität
*Polishing paste for ornamental rings to maintain
optical quality*
- Vorbereitung für Montage mittels Gewindemuffen
Preparation for threaded sleeve assembly

Sie wollen mehr wissen? Unser Verkaufsteam freut sich
auf Ihre Anfrage!

*Want to find out more? Our sales team is looking forward
to receiving your enquiry!*



Chrom | Chrome

Messing | Brass

BEFESTIGUNGSMÖGLICHKEITEN

FIXING OPTIONS

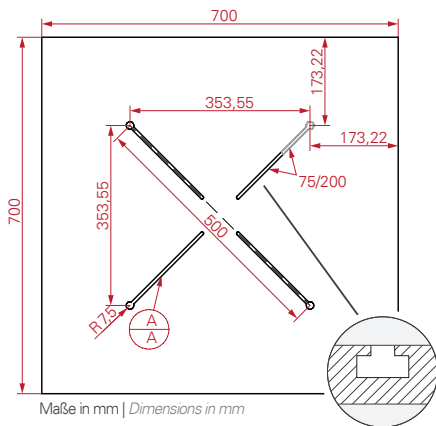

1 Befestigungssystem Exklusiv

Exklusiv fixing system

Erhältlich gegen Aufpreis mit 8 Schrauben (lang) oder 4 Schrauben (kurz); einfache Montage durch eingefräste Nuten auf der Unterseite; passende Schraubensets mit Unterlegscheiben, Muttern und Abdeckkappen; für Plattenstärke 12 mm; individuelle Anpassung möglich.

Available with 8 screws (long) or 4 screws (short) for a surcharge; easy installation thanks to milled grooves on the underside; matching screw sets with washers, nuts and cover caps; for tabletop thickness of 12 mm; customisation possible.

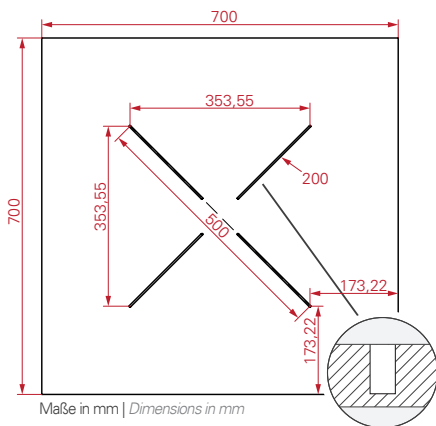

2 Befestigungssystem Econom

Econom fixing system

Erhältlich gegen Aufpreis mit 4 Spezialschrauben; einfache Montage ohne Vorbohren; Lochabstände von 270 mm bis 420 mm; für Plattenstärke 12 mm; individuelle Anpassung möglich.

4 special screws available for a surcharge; easy installation without pre-drilling; hole spacing from 270 mm to 420 mm; for tabletop thickness of 12 mm; customisation possible.

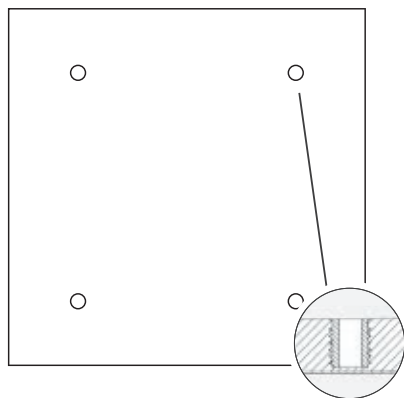

3 Befestigung mit Gewindemuffen M6

Fixing with M6 threaded sleeves

Erhältlich gegen Aufpreis; individuell gesetzte Messing-Gewindemuffen M6 nach Ihren Vorgaben; Zeichnung oder Maßskizze mit Lochabständen erforderlich; einfache Montage mit handelsüblichen Gewindeschrauben M6; für Plattenstärke 12 mm.

Available on payment of a surcharge; customised brass threaded sockets M6 according to your specifications; drawing or dimensional sketch with hole spacing required; easy installation with standard M6 threaded screws; for tabletop thickness of 12 mm.

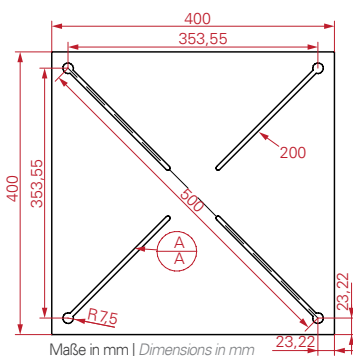

4 Befestigungssystem Montageplatte

Mounting plate fixing system

Vorbereitete Montageplatte sowie Schraubensets für Exklusiv und Econom; Abmessung 400 x 400 mm; Platten werden kundenseitig auf die Tischplattenunterseite geklebt.

Prepared mounting panel as well as screw sets for Exclusive and Economy; dimensions 400 x 400 mm; panels are glued to the underside of the tabletop by the customer.

Hohe PRODUKTIONS- STANDARDS, natürlich

HIGH PRODUCTION STANDARDS, NATURALLY



NACHHALTIG & PERFEKTIONIERT

Was unser perfektioniertes Produktionsverfahren auszeichnet:

- Wesentlich höher verdichtetes Kernmaterial verglichen zu herkömmlichen Spanplatten
- Außergewöhnlich hoher Harzanteil
- Unter großem Druck und hohen Temperaturen werden Holzspäne und melaminbeharzte Papierfolien in einem Stück formgepresst und so zu einer untrennbaren, stabilen Einheit.

In unserem Produktionswerk in Ampflwang – Oberösterreich – erfolgt die Verarbeitung bester europäischer Hölzer aus nachhaltiger Forstwirtschaft.

SUSTAINABLE & PERFECTED

Our perfected production process is characterised by:

- *Substantially more compact core material compared to conventional chipboards*
- *Exceptionally high resin content*
- *Wood chips and coating are moulded in one piece under high pressure and high temperatures to form an inseparable, stable unit.*

In our production plant in Ampflwang – Upper Austria – only top quality European woods from sustainable forestry are processed.

PRODUKTVORTEILE PRODUCT ADVANTAGES



XD OBERFLÄCHE®
XD SURFACE®



E1-ZERTIFIZIERT
E1 CERTIFIED



MADE IN AUSTRIA



UMWELTFREUNDLICH
ENVIRONMENTALLY FRIENDLY



2 JAHRE GARANTIE
2-YEAR GUARANTEE



FUGENLOSE OBERFLÄCHE
JOINTLESS SURFACE



BRUCH- UND SCHLAGFEST
BREAK- AND SHOCK-RESISTANT



HITZEBESTÄNDIG
HEAT-RESISTANT



PFLEGELEICHT
EASY TO CLEAN



ZIGARETTENRUßBESTÄNDIG
RESISTANT TO CIGARETTE ASH



UV-LICHTBESTÄNDIG
RESISTANT TO UV LIGHT



WETTERFEST
WEATHER-RESISTANT



















LFGB-ZERTIFIZIERT
LFGB CERTIFIED





PEFC

DATEN CLASSICLINE | CLASSICLINE SPECIFICATIONS

Form Shape	Dimension in cm Dimensions in cm	Dimension in inch Dimensions in inch	Kantenprofil in mm Edge profile in mm	Formatnummer Format number	Palettenabmessungen in cm l x b x h Pallet dimensions in cm l x w x h	ø Gewicht je Tischplatte in kg ø Weight per tabletop in kg	Bruttogewicht in kg Gross weight in kg	Stk. pro Palette Pieces per pallet	ø Gewicht einer Palette in kg ø Weight of a pallet in kg
	ø 60	ø 24		5012	122 x 62 x 140	4,0	~ 4,3	100	430
	ø 60 + Ring	ø 24		5012	82 x 82 x 110	4,0	~ 4,3	25	108
	ø 70	ø 28		5031	82 x 82 x 140	5,0	~ 5,3	50	265
	ø 70 + Ring	ø 28		5031	82 x 82 x 110	5,0	~ 5,3	25	133
	ø 80	ø 32		5029	82 x 82 x 180	7,5	~ 7,9	60	474
	ø 90	ø 36		5030	92 x 92 x 180	9,5	~ 9,9	60	594
	ø 105	ø 42		5040	107 x 107 x 180	12,0	~ 12,4	60	744
	ø 120	ø 48		1200	122 x 122 x 120	14,6	~ 15,1	30	453
	60 x 60	24 x 24		5214	122 x 62 x 180	5,4	~ 5,7	100	570
	70 x 70	28 x 28		5215	82 x 82 x 180	7,7	~ 8,0	50	400
	80 x 80	32 x 32		5217	82 x 82 x 180	9,8	~ 10,3	50	515
	90 x 90	36 x 36		5221	92 x 92 x 180	12,8	~ 13,5	50	675
	110 x 70	44 x 28		5216	122 x 82 x 160	11,8	~ 12,5	45	563
	120 x 80	48 x 32		5220	122 x 82 x 130	13,3	~ 14,3	30	429
	140 x 80	55 x 32		5218	142 x 82 x 130	16,4	~ 17,4	30	522

DATEN SMARTLINE® | SMARTLINE® SPECIFICATIONS

Form Shape	Dimension in cm Dimensions in cm	Dimension in inch Dimensions in inch	Kantenprofil in mm Edge profile in mm	Formatnummer Format number	Palettenabmessungen in cm l x b x h Pallet dimensions in cm l x w x h	ø Gewicht je Tischplatte in kg ø Weight per tabletop in kg	Bruttogewicht in kg Gross weight in kg	Stk. pro Palette Pieces per pallet	ø Gewicht einer Palette in kg ø Weight of a pallet in kg
	ø 70	ø 28		5831	82 x 82 x 100	4,8	~ 5,1	50	255
	ø 80	ø 32		5829	82 x 82 x 100	6,0	~ 6,3	50	315
	60 x 60	24 x 24		5814	122 x 62 x 100	4,4	~ 4,7	100	470
	70 x 70	28 x 28		5815	82 x 82 x 100	6,0	~ 6,3	50	315
	80 x 80	32 x 32		5817	82 x 82 x 100	7,8	~ 8,1	50	405
	120 x 80	48 x 32		5820	122 x 82 x 100	11,3	~ 11,8	50	590
	160 x 90	64 x 36		5807	162 x 92 x 100	17,7	~ 18,2	50	910

PRODUKTION IN *Zentraleuropa*

PRODUCTION IN CENTRAL EUROPE





Dank unseres Produktionsstandortes in Österreich – Zentraleuropa – ist es uns möglich, unsere Waren im europäischen Markt mit kurzen Transportstrecken und dementsprechend verkürzten Lieferzeiten zu versenden.

Thanks to our production site in Austria – Central Europe – we are able to ship our goods within to the European market, using short transportation routes and correspondingly shortened delivery times.



DATEN COMPACTLINE | COMPACTLINE SPECIFICATIONS

Form Shape	Dimension in cm Dimensions in cm	Dimension in inch Dimensions in inch	Kantenprofil in mm Edge profile in mm	Formatnummer Format number	Palettenabmessungen in cm l x b x h Pallet dimensions in cm l x w x h	ø Gewicht je Tischplatte in kg ø Weight per tabletop in kg	Bruttogewicht in kg Gross weight in kg	Stk. pro Palette Pieces per pallet	ø Gewicht einer Palette in kg ø Weight of a pallet in kg
	ø 60	ø 24		5912	80 x 80 x 80	5,2	~ 5,4	50	270
	ø 70	ø 28		5931	80 x 80 x 80	7,2	~ 7,4	50	370
	ø 80	ø 32		5929	82 x 82 x 80	9,4	~ 9,7	50	485
	ø 90	ø 36		—	92 x 92 x 80	11,7	~ 12,0	50	600
	60 x 60	24 x 24		5914	80 x 80 x 80	6,6	~ 6,8	50	340
	70 x 70	28 x 28		5915	80 x 80 x 80	9,0	~ 9,3	50	465
	80 x 80	32 x 32		5917	82 x 82 x 80	11,7	~ 11,9	50	595
	90 x 90	36 x 36		5921	92 x 92 x 80	14,9	~ 15,2	50	760
	110 x 70	44 x 28		5922	112 x 72 x 80	14,1	~ 14,4	50	720
	120 x 80	48 x 32		5920	122 x 82 x 80	17,6	~ 17,9	50	895
	140 x 80	55 x 32		5218	142 x 82 x 80	20,6	~ 20,9	50	1045

Weitere Formate auf Anfrage erhältlich.
Additional formats on request.

¹ Lieferzeit auf Anfrage.

Die Bestellnummern setzen sich aus der Formatnummer (4 Zahlen) und der angehängten Dekornummer (4 Zahlen) zusammen.

¹ Delivery time on request.

The order numbers are composed of the format number (4 digits) and the associated décor number (4 digits).

DESIGN

Compact Line

COMPACT LINE DESIGNS



Atacama Cherry 0222



Bianco 0445

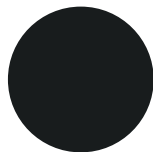

Black 0407*



Black Marmor 0444*



Brushed Silver 0107



Dark Slate 0231*



Iceland 0253



Industrial 0240

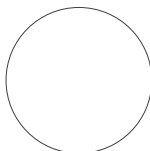

Pure White 0406

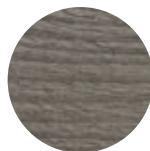

Timber 0214*

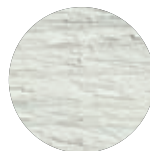

Timber White 0232



White Marmor 0070

DEKORAUSWAHL

HPL

2025 / 26

SELECTION OF DÉCORS

DESIGN Holz

WOOD DESIGNS



Alpinemaple 0250



Artisan 0248

NEW



Atacama Cherry 0222



Benett 0235*

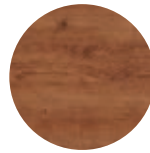

Bob's Pine 0236*



Fala 0443

NEW



Iceland 0253



Maritimo Pine 0216

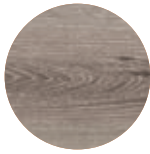

Messina Oak 0227



Oak 0219



Oak Light 0241

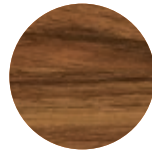

Teak 0009*



Tilia Tree 0220

RUN OUT

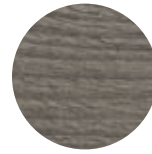

Timber 0214*

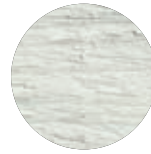

Timber White 0232

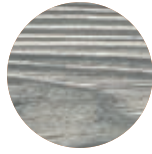

Urban Spruce 0217



Vintage 0218



Washed Elm 0228



Washington Pine 0226



Wenge 0106*



White Wood 0224



Zebrano 0242

RUN OUT

DESIGN Stein

STONE DESIGNS

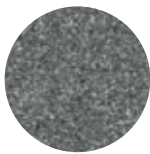

Balota 0119*

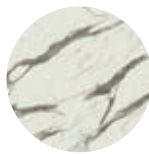

Bianco 0445



Black Marmor 0444*



Dark Slate 0231*

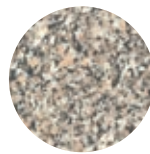

Granit 0067

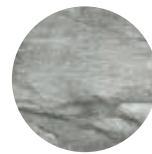

Grizzly 0121



Industrial 0240



Lavant 0254*

NEW



Marble 0246



Nevada 0116

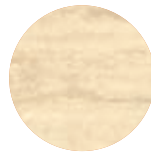

Travertin 0034



Utah Brown 0223

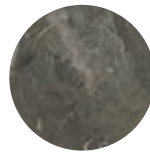

Veneto 0249



White Marmor 0070

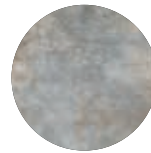

Zinc 0146

DESIGN Uni

MONOCHROME DESIGNS



Beige 0230

RUN OUT

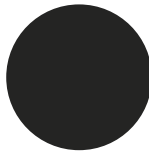

Black 0407*



Cremeweiß 0056

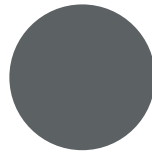

Dark Grey 0252*

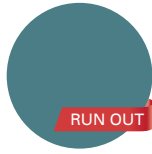

Petrol 0411

RUN OUT

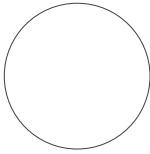

Pure White 0406



Red 0403

DEKORAUSSWAHL

CL + SL

2025 / 26

SELECTION OF DÉCORS

DESIGN Grafik

GRAPHIC DESIGNS



Anthracite 0074*



Aurum 0446*

NEW



Brushed Silver 0107



Coffee Sack 0233



Concrete 0152*



Cyprus Metal 0229*



Etain 0002

RUN OUT



Maracaibo 0251



Newspaper 0151



Planchas Blue 0237

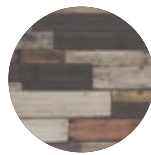

Planchas Brown 0238



Planchas Red 0239



Rusty Plates 0234

RUN OUT

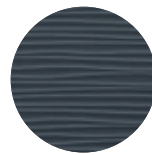

Seagrass Dark 0139*

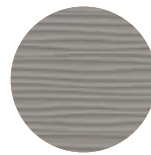

Seagrass Grey 0138



Seagrass Light 0137



Versailles 0131

RUN OUT

Achtung: Durch Verpressung der Folie unter Druck und Wärmeeinwirkung, können die dargestellten Farben leichte Veränderungen unterliegen.
Attention: Due to the sealing of the film under pressure and heat, the colours shown may be subject to slight changes.

FACTSHEET

ALLGEMEINES

Topalit® Formteile werden nach einem speziellen Formpressverfahren hergestellt. Mit unserer langjährigen Erfahrung und unserem Know-how setzen wir nachweislich unserer Umwelt und der Zukunft zuliebe auf Nachhaltigkeit.

UV-LICHTBESTÄNDIGKEIT

Durch die hohe UV-Beständigkeit sind Topalit® Tischplatten ideal für den Outdoor-Einsatz geeignet. Bei direkter Sonneneinstrahlung wird die Verwendung von hellen Dekoren empfohlen. Dunkle Dekore können sich unter Sonneneinstrahlung auf über 80 °C erhitzen und aufgrund eines physikalischen Effektes bei einseitiger Erwärmung von Tischplatten kann es zu temporären Verformungen kommen. Um diesen entgegenzuwirken, werden die Platten im Produktionsprozess konvex vorgespannt. Diese Vorspannung reduziert sich unter Sonneneinstrahlung. Aufgrund dieser Vorspannung sind Topalit® Tischplatten nicht zur Tafelbildung geeignet.

GESTELL-EMPFEHLUNG

Bei Tischplatten ab der Größe 110x70 cm und bei allen Smartline® Tischplatten empfehlen wir den Einsatz von Tischgestellen mit umlaufendem Rahmen. Bei diesen Gestellen muss auf eine ausreichende Unterstützung der Tischplatte geachtet werden, da sonst eine Verformung nicht ausgeschlossen werden kann.

Fragen Sie unseren Vertriebsaußendienst nach weiteren Erläuterungen.
Auf Anfrage senden wir Ihnen die Vollversion unserer Factsheets zu.

LAGERUNG

Es wird empfohlen, Topalit® Tischplatten trocken zu lagern. Lagern Sie die Tischplatten unter freien Umgebungsbedingungen immer mit der Dekorseite nach oben. Dadurch kann das Regenwasser von der Classic- und Smartline®-platte ablaufen.

GENERAL INFORMATION

Topalit® mouldings are manufactured according to a special moulding process. With our many years of experience and expertise, we have proven our commitment to sustainability for the sake of our environment and the future.

RESISTANCE TO UV LIGHT

Due to their high level of resistance to UV light, Topalit® tabletops are ideal for outdoor use. In direct sunlight, the use of bright décors is recommended. Dark décors can heat up to over 80 °C in sunlight and temporary deformations can occur due to a physical effect when tabletops are heated on one side. In order to counteract this, the tabletops are prestressed convexly during the production process. This prestressing reduces under the effects of sunlight. Due to this prestressing, Topalit® tabletops are not suitable for forming panels.

RECOMMENDED FRAME

For tabletops sized 110x70 cm and above and for all Smartline® tabletops, we recommend the use of table frames with a circumferential frame. With these frames, care must be taken to ensure that the table top is sufficiently supported, otherwise the possibility deformation cannot be ruled out.

Ask our sales force team for further explanations. On request, we will send you the full version of our fact sheets.

STORAGE

We recommend storing Topalit® tabletops dry. Always store the tabletops with the decorative side facing upwards in open environmental conditions. This allows rainwater to run off the Classic and Smartline® tabletops.

Designed TO RESIST

Auflage 1 / 2025/26 / 91110
Edition 1 / 2025/26 / 91110

Nachdruck oder sonstige Wiedergabe auch auszugsweise nur mit Genehmigung des Herausgebers. Druckfehler und technische Änderungen vorbehalten.

The reprinting or reproduction of this text, including excerpts, is only permitted with the publisher's prior consent. Printing errors excepted. Subject to technical modifications.